



---

# ***Using the TPS51020 High-Performance Synchronous Buck***

*User's Guide*

## EVM IMPORTANT NOTICE (CATEGORY B)

IMPORTANT: TI is providing the enclosed **HPA064** evaluation module under the following conditions:

This evaluation module (EVM) being provided by Texas Instruments (TI) is intended for use for **ENGINEERING DEVELOPMENT OR EVALUATION PURPOSES ONLY** and is not considered by Texas Instruments to be fit for commercial use. As such, this EVM may not be complete in terms of design and/or manufacturing related protective considerations including product safety measures typically found in the end-product incorporating the module. As a prototype, this product does not fall within the scope of the European Union Directive on electromagnetic compatibility and on low voltage and therefore may not meet the technical requirements of the directive. This EVM is not subject to the EU marking requirements.

- Should this EVM not meet the specifications indicated in the User's Guide the EVM may be returned within 30 days from the date of delivery for a full refund. **THE FOREGOING WARRANTY IS THE EXCLUSIVE WARRANTY MADE BY TI AND IS IN LIEU OF ALL OTHER WARRANTIES, EXPRESSED, IMPLIED, OR STATUTORY, INCLUDING ANY WARRANTY OF MERCHANTABILITY OR FITNESS FOR ANY PARTICULAR PURPOSE.**
- The user assumes all responsibility and liability for proper and safe handling of the EVM. The user acknowledges that the use of the EVM could present serious hazards and that it is the user's responsibility to take all precautions for the handling and use of the EVMs in accordance with good laboratory practices. Please be aware that the products received may not be regulatory compliant or agency certified (FCC, UL, etc.). Due to the open construction of the product, it is the user's responsibility to take any and all appropriate precautions with regard to electrostatic discharge.
- **NEITHER PARTY WILL BE LIABLE TO THE OTHER FOR ANY INDIRECT, SPECIAL, INCIDENTAL, OR CONSEQUENTIAL DAMAGES.**
- TI is currently dealing with various customers for products, and therefore our arrangement with the user **will not be exclusive.**
- TI assumes **no liability for applications assistance, customer product design, software performance, or infringement of patents or services described herein.**
- Please read the User's Guide and specifically the section in the User's Guide pertaining to warnings and restrictions prior to handling the product. This section contains important information regarding high temperature and voltages which TI recommends to be read before handling the EVMs. In case of any doubt regarding safety, please contact the TI application engineer.
- Persons handling the product should have electronics training and observe good laboratory practice standards.
- No license is granted under any patent right or other intellectual property right of TI covering or relating to any combination, machine, or process in which such TI products or services might be or are used.
- This Agreement is subject to the laws of the State of Texas, excluding the body of conflicts of laws and the United Nations Convention on the International Sale of Goods, and will be subject to the exclusive jurisdiction of the courts of the State of Texas.

### **DYNAMIC WARNINGS AND RESTRICTIONS**

It is important to operate this EVM within the maximum input voltage ranges specified in Table 4.

Exceeding the specified input range may cause unexpected operation and/or irreversible damage to the EVM. If there are questions concerning the input range, please contact a TI field representative prior to connecting the input power.

Applying loads outside of the specified output range may result in unintended operation and/or possible permanent damage to the EVM. Please consult the EVM User's Guide prior to connecting any load to the EVM output. If there is uncertainty as to the load specification, please contact a TI field representative.

During normal operation, some circuit components may have case temperatures greater than 50°C. The EVM is designed to operate properly with certain components above 50°C as long as the input and output ranges are maintained. These components include but are not limited to linear regulators, switching transistors, pass transistors, and current sense resistors. These types of devices can be identified using the EVM schematic located in the EVM User's Guide. When placing measurement probes near these devices during operation, please be aware that these devices may be very warm to the touch.

Mailing Address:

Texas Instruments  
Post Office Box 655303  
Dallas, Texas 75265

Copyright © 2004, Texas Instruments Incorporated

# Using the TPS51020

## High-Performance Buck Controller Evaluation Module

---

*Portable Power Products*

### CONTENTS

<b>1</b>	<b>Descripton .....</b>	<b>4</b>
<b>2</b>	<b>Electrical Perfomance Specifications .....</b>	<b>5</b>
<b>3</b>	<b>Schematic .....</b>	<b>5</b>
<b>4</b>	<b>Test Setup and Results .....</b>	<b>7</b>
<b>5</b>	<b>EVM Assembly Drawing and PCB Layout .....</b>	<b>11</b>
<b>6</b>	<b>List of Materials .....</b>	<b>14</b>
<b>7</b>	<b>References .....</b>	<b>15</b>

## **1 Introduction**

The TPS51020 is a multi-function dual-synchronous step-down controller. The part is specifically designed for high performance, high-efficiency applications where the loss associated with a current sense resistor is unacceptable. The TPS51020 uses feed-forward voltage mode control to improve the line response. Efficiency at light load conditions can be maintained high as well by incorporating auto-skip operation. The TPS51020 can be used in notebook computer system bus and I/O, DDR I or DDR II termination applications, distributed power and point-of-load regulation for DSPs, FPGAs, ASICs, etc. in servers, base stations, and broadband, networking or optical communications systems.

TPS51020EVM-001 evaluation module (EVM) is a high-efficiency, dual synchronous buck converter providing 5 V at 6.0 A and 3.3 V at 6.0 A from an 8.0 V to 20 V input. The TPS51020 operates at 300 kHz with a peak efficiency of 94.8% with both channels enabled. This user's guide describes the TPS51020EVM-001 performance in dual mode.

## 2 Electrical Performance Specifications

A summary of performance specifications for TPS51020EVM–001 is provided in Table 1.

### 2.1 Performance Specification Summary

Table 1. Performance Specification Summary<sup>(1)</sup>

SPECIFICATION	TEST CONDITIONS	MIN	TYP	MAX	UNIT
<b>GENERAL</b>					
Input voltage range, $V_{IN(DC)}$		8	12	20	V
Operating frequency			300		kHz
Input ripple voltage (RMS value)	$V_{IN} = 12\text{ V}$ , $I_{OUT1} = 6\text{ A}$ , $I_{OUT2} = 6\text{ A}$		194		mV
<b>CHANNEL1 (<math>V_{O1}</math>, GND)</b>					
Maximum output current	$8\text{ V} \leq V_{IN} \leq 20\text{ V}$ ,	6			A
Output voltage		4.85	5.00	5.13	V
Line regulation	$I_{OUT1} = 6\text{ A}$ , $8\text{ V} \leq V_{IN} \leq 20\text{ V}$			0.1%	
Load regulation	$V_{IN} = 12\text{ V}$ , $0\text{ A} \leq I_{OUT1} \leq 6\text{ A}$			0.1%	
Load transient response voltage change	$I_{OUT1}$ rising from 0 A to 5 A		30		mV <sub>P-P</sub>
	$I_{OUT1}$ falling from 5 A to 0 A		60		
Load transient response recovery time	$I_{OUT1}$ rising from 0 A to 5 A			500	$\mu\text{s}$
	$I_{OUT1}$ falling from 5 A to 0 A			500	
Loop bandwidth	$I_{OUT1} = 6\text{ A}$ , $V_{IN} = 12\text{ V}$		14		kHz
Phase margin	$I_{OUT1} = 6\text{ A}$ , $V_{IN} = 12\text{ V}$		32		$^{\circ}$
Output ripple voltage	$I_{OUT1} = 6\text{ A}$ , $V_{IN} = 12\text{ V}$		36	60	mV <sub>P-P</sub>
Output rise time	$I_{OUT1} = 6\text{ A}$ , $V_{IN} = 12\text{ V}$ , $V_{O1} = 5\text{ V}$		4.6		ms
Full load efficiency	$I_{OUT1} = 6\text{ A}$ , $I_{OUT2} = 0\text{ A}$ , $V_{IN} = 12\text{ V}$ , $V_{O1} = 5\text{ V}$		93.9%		
<b>CHANNEL2 (<math>V_{O2}</math>, GND)</b>					
Maximum output current	$8\text{ V} \leq V_{IN} \leq 20\text{ V}$ ,	6			A
Output voltage		3.21	3.30	3.38	V
Line regulation	$I_{OUT2} = 6\text{ A}$ , $8\text{ V} \leq V_{IN} \leq 20\text{ V}$			0.1%	
Load regulation	$V_{IN} = 12\text{ V}$ , $0\text{ A} \leq I_{OUT2} \leq 6\text{ A}$			0.2%	
Load transient response voltage change	$I_{OUT2}$ rising from 0 A to 5 A		50		mV <sub>P-P</sub>
	$I_{OUT2}$ falling from 5 A to 0 A		50		
Load transient response recovery time	$I_{OUT2}$ rising from 0 A to 5 A			500	$\mu\text{s}$
	$I_{OUT2}$ falling from 5 A to 0 A			500	
Loop bandwidth	$I_{OUT2} = 6\text{ A}$ , $V_{IN} = 12\text{ V}$		15		kHz
Phase margin	$I_{OUT2} = 6\text{ A}$ , $V_{IN} = 12\text{ V}$		41		$^{\circ}$
Output ripple voltage	$I_{OUT2} = 6\text{ A}$ , $V_{IN} = 12\text{ V}$		34	60	mV <sub>P-P</sub>
Output rise time	$I_{OUT2} = 6\text{ A}$ , $V_{IN} = 12\text{ V}$ , $V_{O2} = 3.3\text{ V}$		4.72		ms
Full load efficiency	$I_{OUT1} = 0\text{ A}$ , $I_{OUT2} = 6\text{ A}$ , $V_{IN} = 12\text{ V}$ , $V_{O2} = 3.3\text{ V}$		91.3%		

## 3 TPS51020EVM–001 Circuit Module Schematic

Figure 1 shows the TPS51020EVM–001 circuit module schematic diagram.

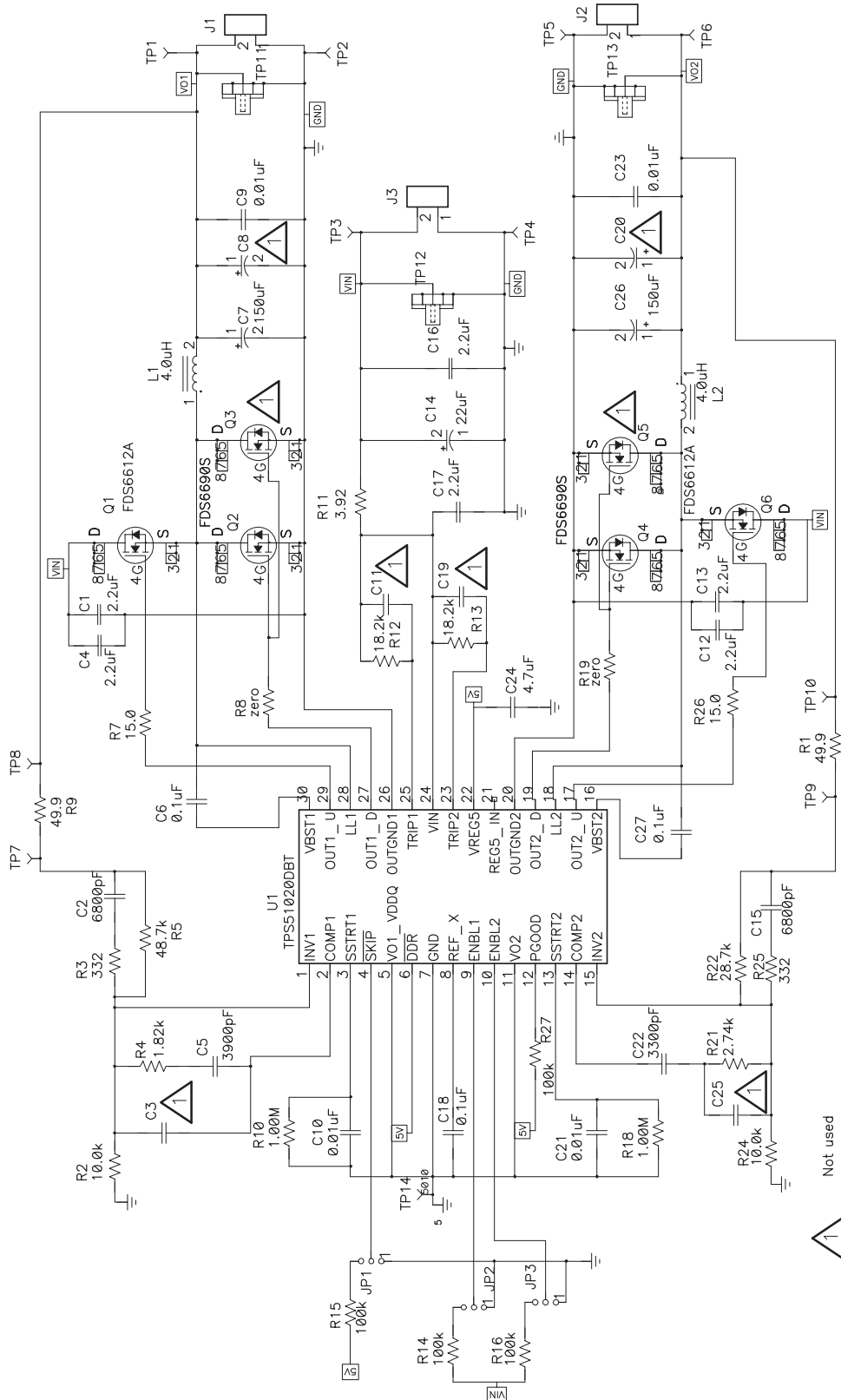

Figure 1. TPS51020EVM-001 Schematic

## 4 Test Setup and Results

### 4.1 Test Setup

The HPA064 has the following input/output connections: 12-V input through J3 (VIN and GND), 5.0-V output through J1 (VO1 and GND), 3.3-V output through J2 (VO2 and GND). A diagram showing the connection points is shown in Figure 2. A power supply capable of supplying 6 A should be connected to VIN and GND through a pair of 16 AWG wires. The 5.0-V and 3.3-V loads should be connected respectively to VO1, GND and VO2, GND2 through pairs of 16 AWG wires. Wire lengths should be minimized to reduce losses in the wires.

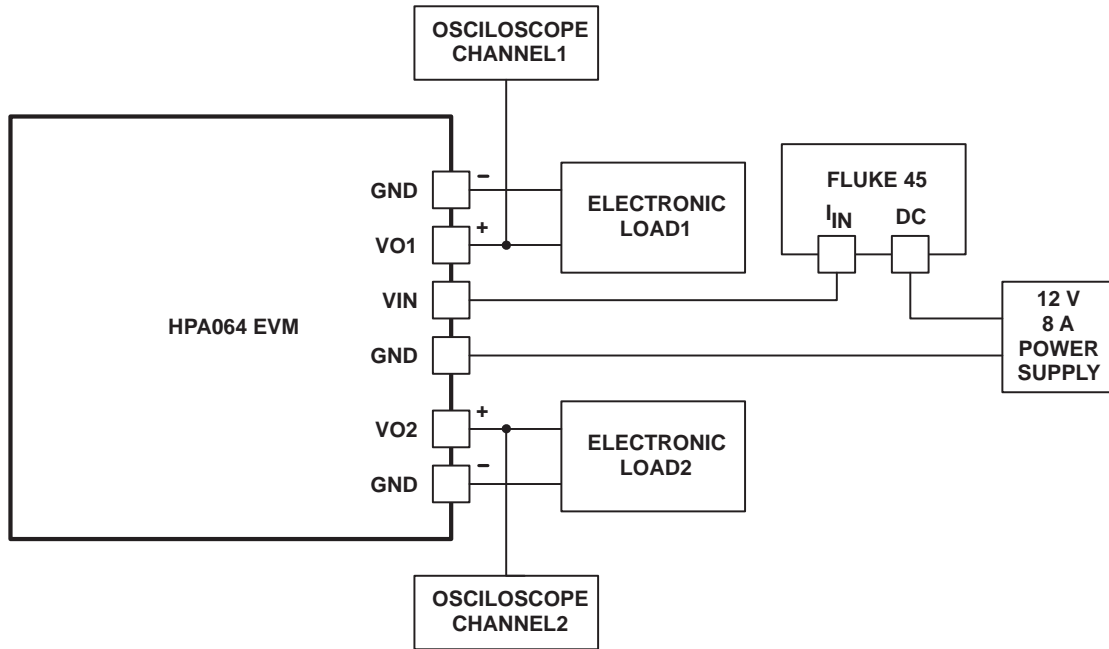
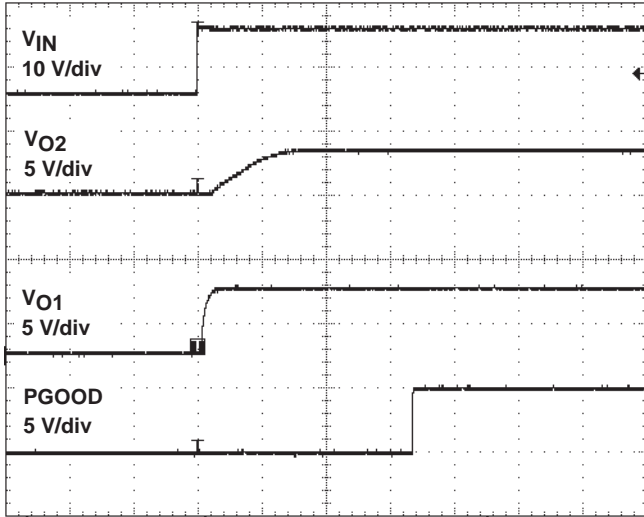

Figure 2. TPS51020EVM-001 Schematic

## 4.2 Power-Up and Power-Down

Figures 3 and 4 show the power-up and power-down waveforms. The powergood (PGOOD) pin jumps to high after both outputs have started and have been in regulation for 2048 clock pulses (6.8 ms).



t – Time – 5 ms/div

Figure 3. Power-Up Waveform

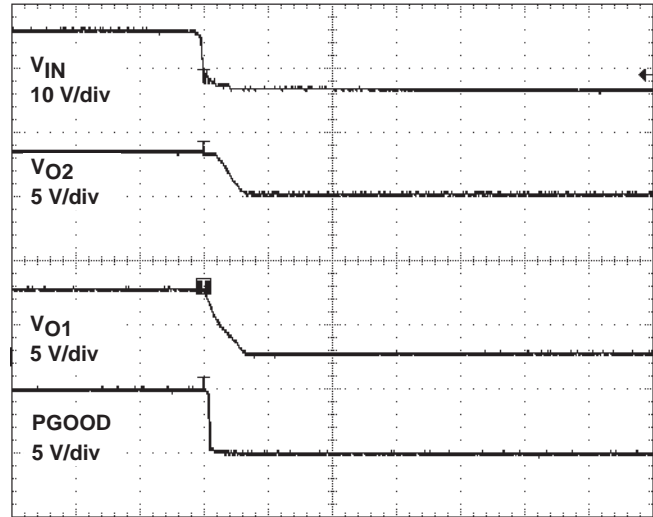

t – Time – 500  $\mu$ s/div

Figure 4. Power-Down Waveform



### 4.3 Efficiency and Power Loss

Figures 5 and 6 show the test efficiency and power losses vs. load current at different conditions. The maximum efficiency is approximately 94.8% when both channels are enabled. The total power loss is 3.5 W when both channels are on and delivering 6.0 A.

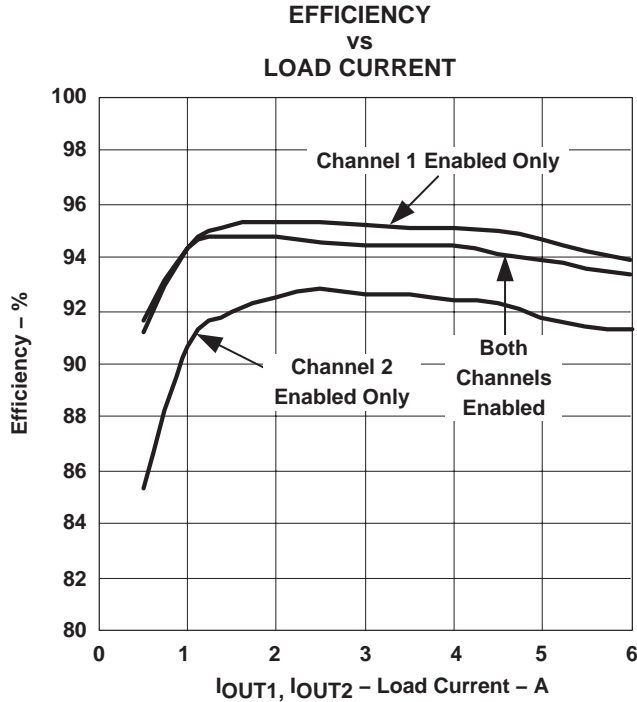

Figure 5.

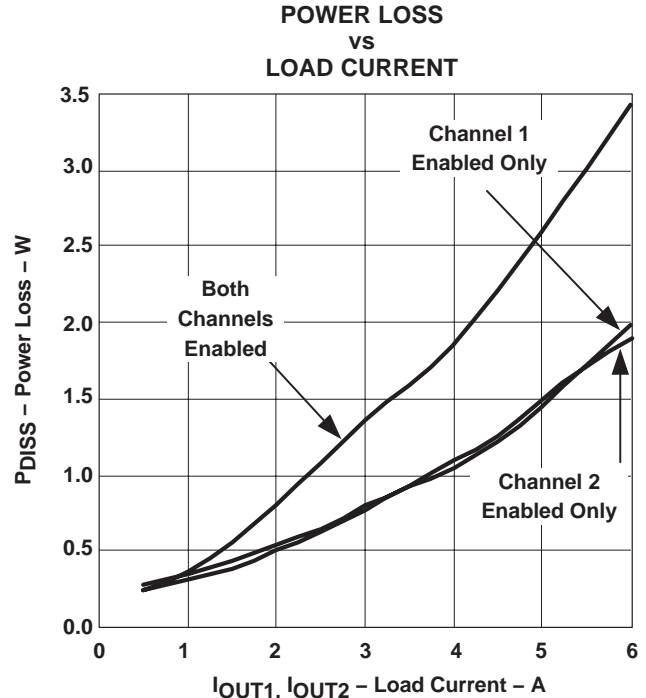

Figure 6.

### 4.4 Output Ripple

In Figure 7 the output ripple waveform shows that two channels are running at 180° phase shift. The peak-to-peak ripple voltage is less than 40 mV in each channel.

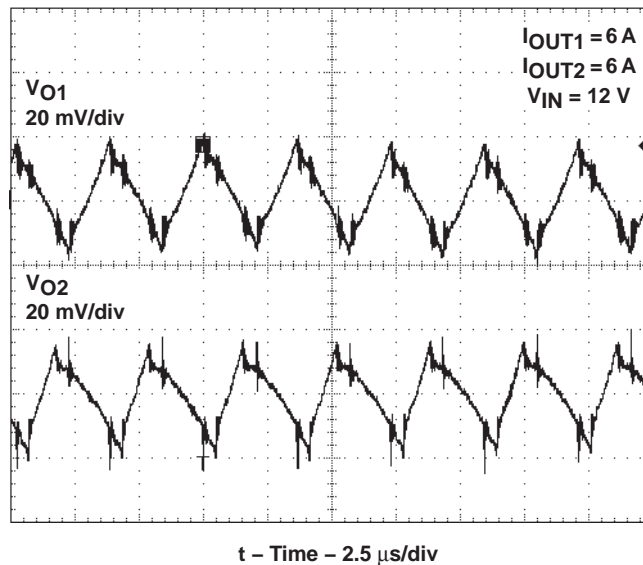

Figure 7. Output Ripple

### 4.5 Load Transient

Figures 8 and 9 show the load transient waveforms for each channel. When load is stepped from 0 A to 5 A, the undershoot voltage is less than 60 mV and the settling time is less than 30  $\mu$ s. When load is stepped down from 5 A to 0 A, the overshoot voltage is less than 50 mV and the settling time is less than 50  $\mu$ s.

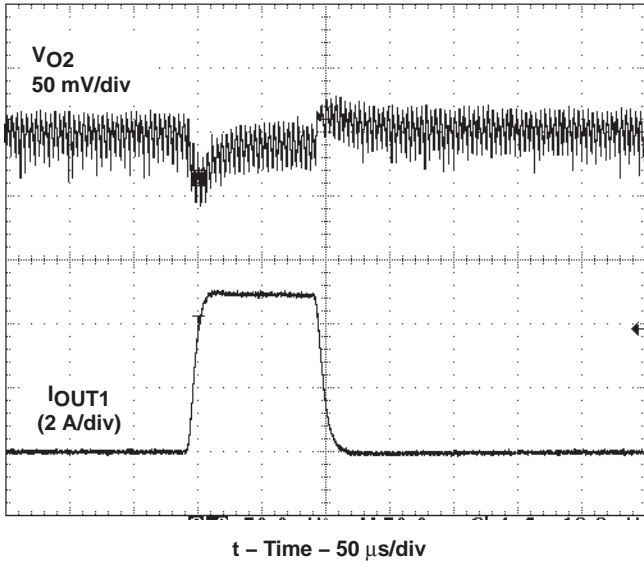

Figure 8. Channel 1 Load Transient Waveform

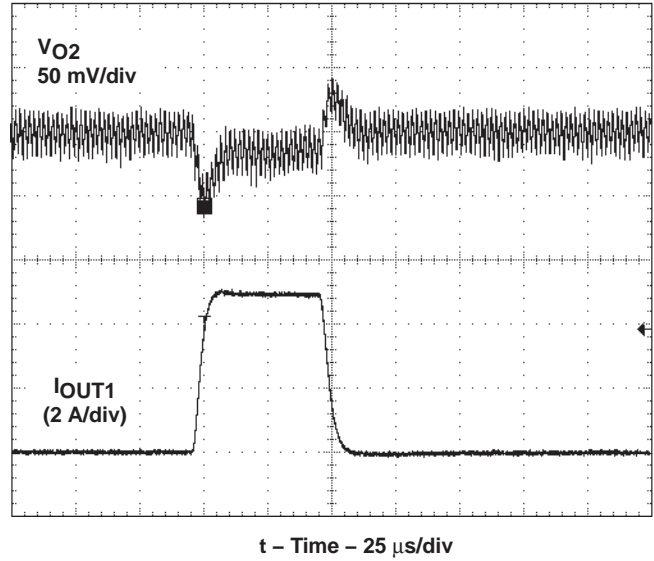

Figure 9. Channel 2 Load Transient Waveform

### 4.6 Loop Characteristics

Figures 10 and 11 show the bode plot of each channel. The crossover frequency is approximately 14 kHz and the phase margin is 32° for Channel 1 when the output is 5 V and 6 A. Channel 2 shows a 15-kHz crossover frequency and a 41° phase margin.

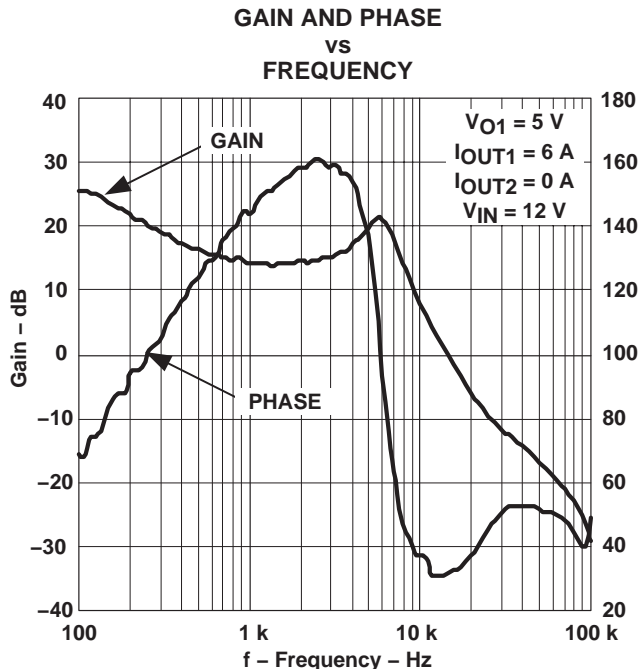

Figure 10. Channel 1 Bode Plot

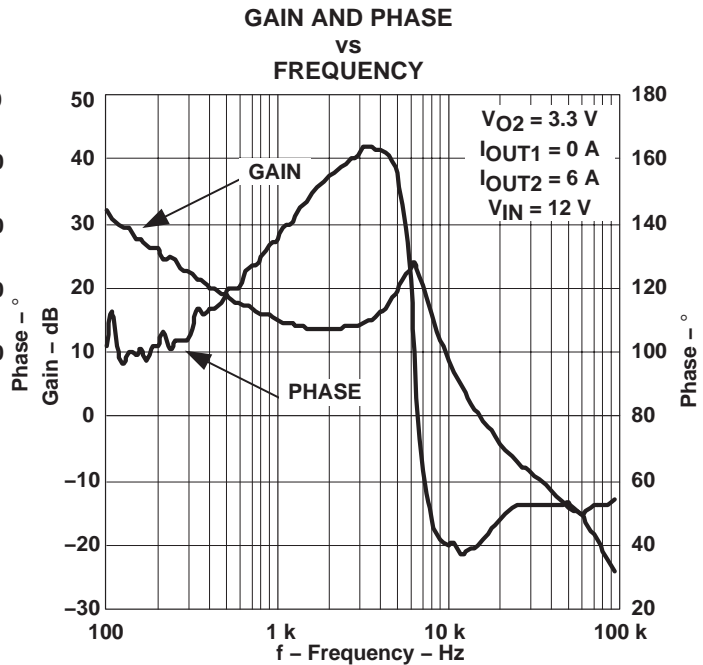

Figure 11. Channel 2 Bode Plot

## 5 TPS51020EVM-001 Assembly Drawing and PCB Layout

Figures 12 through 16 show the assembly drawing and each layer.

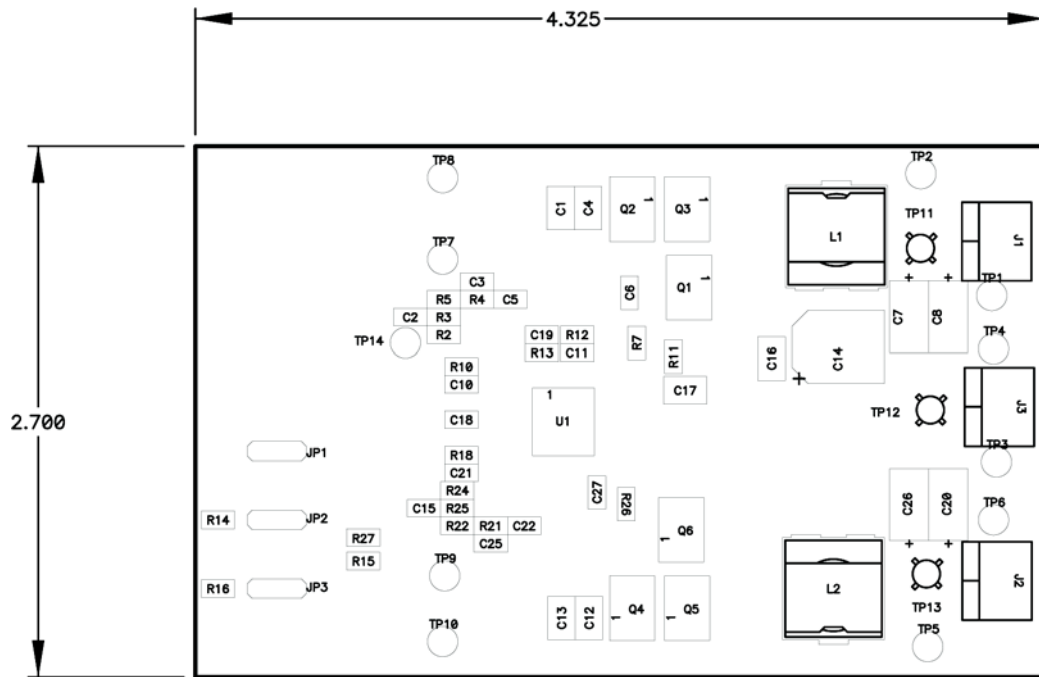

Figure 12. Top Assembly

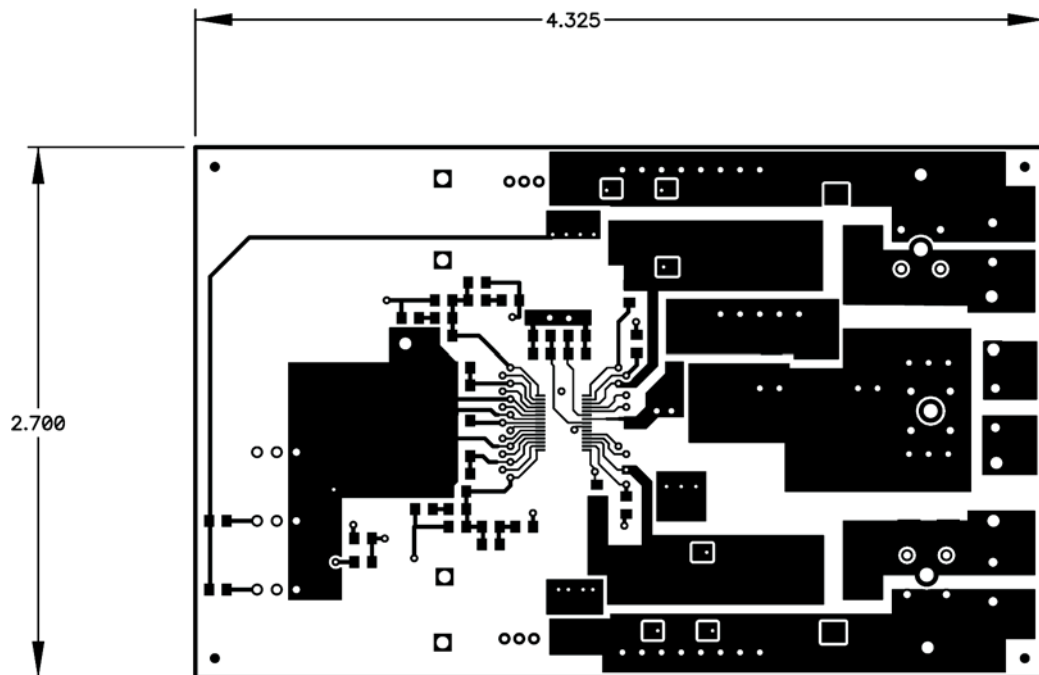

Figure 13. Top Layer

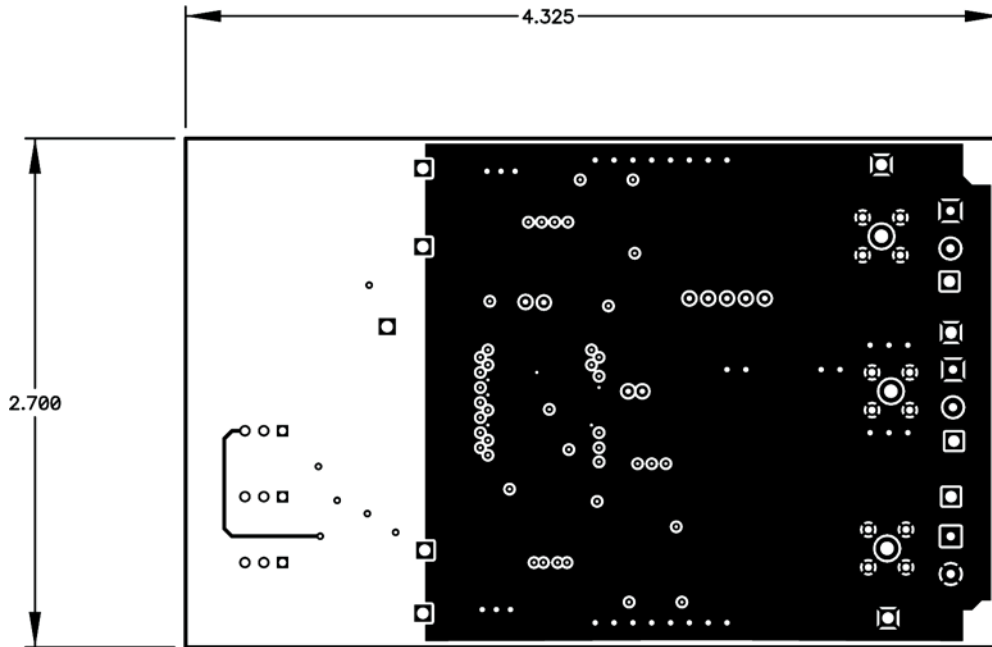

Figure 14. Inner Layer 1

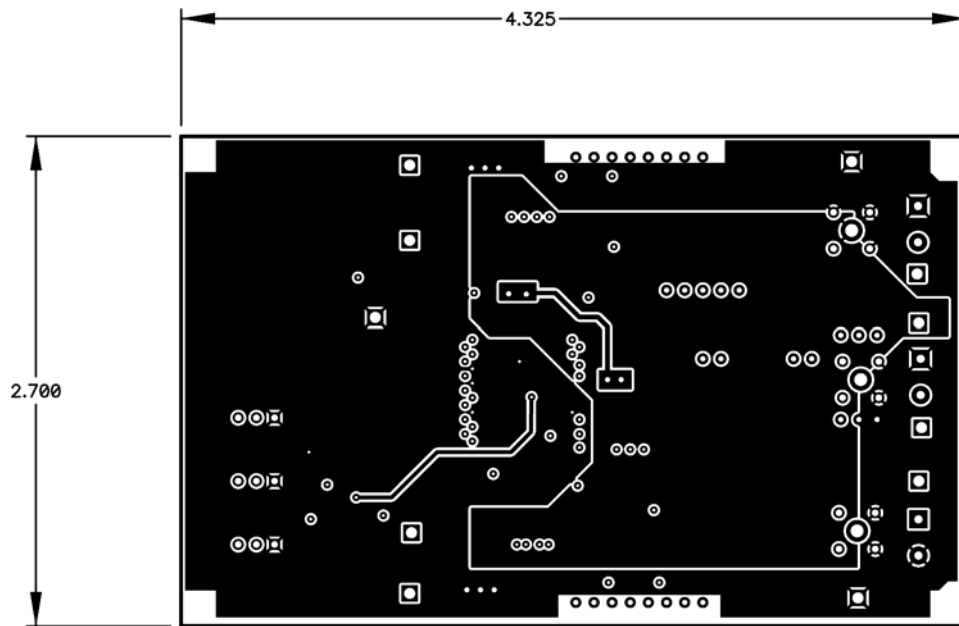

Figure 15. Inner Layer 2

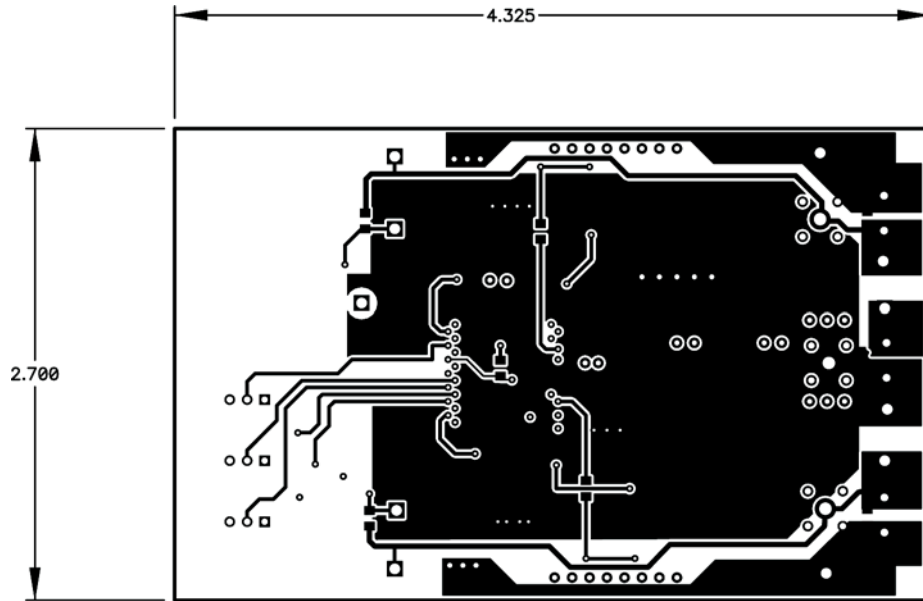

Figure 16. Bottom Layer

## 6 TPS51020EVM–001 Circuit Module List of Materials

List of materials required for the TPS51020EVM–001.

**Table 2. List of Materials**

RERERENCE DESIGNATOR	QTY	DESCRIPTION	SIZE	MFR	PART NUMBER
C1, C4, C12, C13, C16, C17	6	Capacitor, ceramic, 2.2 $\mu$ F, 25 V, X5R, 10%	1210	Panasonic	ECJ–4YB1E225K
C2, C15	2	Capacitor, ceramic, 6800 pF, 25 V, X7R, 10%	805	Std	Std
C3, C11, C19, C25	0	Capacitor, ceramic, TBD	805	Std	Std
C24	1	Capacitor, ceramic, 4.7 $\mu$ F, 25 V, X5R, 10%	805	Panasonic	ECJ–2FB1E475M
C22	1	Capacitor, ceramic, 3300 pF, 25 V, X7R, 5%	805	Std	Std
C14	1	Capacitor, aluminum solid cap, with conductive polymer 22 $\mu$ F, 35 V, 20%	8.3m (E7)	Sanyo	35SVPD22M
C5	1	Capacitor, ceramic, 3900 pF, 25 V, X7R, 5%	805	Std	Std
C6, C18, C27	3	Capacitor, ceramic, 0.1 $\mu$ F, 25 V, X7R, 10%	805	Std	Std
C7, C26	2	Capacitor, aluminum, 150 $\mu$ F, 6.3 V, 20% (UE Series)	7343	Panasonic	EEF–UE0J151R
C8, C20	0	Capacitor, aluminum, 150 $\mu$ F, 6.3 V, 20% (UE Series)	7343	Panasonic	EEF–UE0J151R
C9, C10, C21, C23	4	Capacitor, ceramic, 0.01 $\mu$ F, 25 V, X7R, 10%	805	Std	Std
L1, L2	2	Inductor, SMT, 4.0 $\mu$ H, 10.3 A, 8.0 m $\Omega$	0.492 sq"	Sumida	CEP125(H)–4R0
Shorts Jumper	3	STC02SYAN	Shorts Jumper	Sullins	N/A
JP, JP2, JP3	3	Header, 3 pin, 100mil spacing, (36 pin strip)	0.100 $\times$ 3	Sullins	PTC36SAAN
R1, R9	2	Resistor, chip, 49.9 $\Omega$ , 1/10–W, 1%	805	Vishay	Std
R10, R18	2	Resistor, chip, 1M $\Omega$ , 1/10W, 1%	805	Vishay	Std
R4	1	Resistor, chip, 1.82 k $\Omega$ , 1/10W, 1%	805	Vishay	Std
R21	1	Resistor, chip, 2.74 k $\Omega$ , 1/10W, 1%	805	Vishay	Std
R11	1	Resistor, chip, 3.92 k $\Omega$ , 1/10W, 1%	805	Vishay	Std
R2, R24	2	Resistor, chip, 10.0 k $\Omega$ , 1/10W, 1%	805	Vishay	Std
R7, R26	2	Resistor, chip, 15 $\Omega$ , 1/10W, 1%	805	Vishay	Std
R12, R13	2	Resistor, chip, 18.2 k $\Omega$ , 1/10W, 1%	805	Vishay	Std
R22	1	Resistor, chip, 28.7 k $\Omega$ s, 1/10W, 1%	805	Vishay	Std
R5	1	Resistor, chip, 48.7 k $\Omega$ s, 1/10W, 1%	805	Vishay	Std
R14, R15, R16, R27	4	Resistor, chip, 100 k $\Omega$ , 1/10W, 1%	805	Vishay	Std
R3, R25	2	Resistor, chip, 332 $\Omega$ , 1/10W, 1%	805	Vishay	Std
R8, R19	2	Resistor, chip, 0 $\Omega$ , 1/10W, 1%	805	Vishay	Std
J1, J2, J3	3	Terminal block, 2 pin, 15 A, 5.1mm	0.40 $\times$ 0.35	OST	ED1609
TP1, TP3, TP6, TP8, TP10	5	Test point, 0.062 hole, red	0.25	Keystone	5011
TP2, TP4, TP5, TP7, TP9, TP14	6	Test point, 0.062 hole, black	0.25	Keystone	5010
U1	1	Dual voltage mode, DDR selectable, synchronous, step-down controller for notebook	TSSOP30	TI	TPS51020DBT
TP11, T12, TP13	3	Adaptor, 3.5 mm probe clip (or 131–5031–00)	0.2	Tektronix	131–4244–00
Q1, Q6	2	Transistor, MOSFET, N-channel, 30 V, 8.4 A, Rds 22 m $\Omega$	SO–8	Fairchild	FDS6612A
Q2, Q4	2	Transistor, MOSFET, N-channel, 30 V, 10 A, Rds 16 m $\Omega$	SO–8	Fairchild	FDS6690S
Q3, Q5	0	Transistor, MOSFET, N-channel, 30 V, 10 A, Rds 16 m $\Omega$	SO–8	Fairchild	FDS6690S

## **7 References**

1. TPS51020 Datasheet, Dual, Voltage Mode, DDR Selectable, Synchronous, Step-down Controller for Notebook System (SLUS564B)

## IMPORTANT NOTICE

Texas Instruments Incorporated and its subsidiaries (TI) reserve the right to make corrections, modifications, enhancements, improvements, and other changes to its products and services at any time and to discontinue any product or service without notice. Customers should obtain the latest relevant information before placing orders and should verify that such information is current and complete. All products are sold subject to TI's terms and conditions of sale supplied at the time of order acknowledgment.

TI warrants performance of its hardware products to the specifications applicable at the time of sale in accordance with TI's standard warranty. Testing and other quality control techniques are used to the extent TI deems necessary to support this warranty. Except where mandated by government requirements, testing of all parameters of each product is not necessarily performed.

TI assumes no liability for applications assistance or customer product design. Customers are responsible for their products and applications using TI components. To minimize the risks associated with customer products and applications, customers should provide adequate design and operating safeguards.

TI does not warrant or represent that any license, either express or implied, is granted under any TI patent right, copyright, mask work right, or other TI intellectual property right relating to any combination, machine, or process in which TI products or services are used. Information published by TI regarding third-party products or services does not constitute a license from TI to use such products or services or a warranty or endorsement thereof. Use of such information may require a license from a third party under the patents or other intellectual property of the third party, or a license from TI under the patents or other intellectual property of TI.

Reproduction of information in TI data books or data sheets is permissible only if reproduction is without alteration and is accompanied by all associated warranties, conditions, limitations, and notices. Reproduction of this information with alteration is an unfair and deceptive business practice. TI is not responsible or liable for such altered documentation.

Resale of TI products or services with statements different from or beyond the parameters stated by TI for that product or service voids all express and any implied warranties for the associated TI product or service and is an unfair and deceptive business practice. TI is not responsible or liable for any such statements.

Following are URLs where you can obtain information on other Texas Instruments products and application solutions:

<b>Products</b>		<b>Applications</b>	
Amplifiers	<a href="http://amplifier.ti.com">amplifier.ti.com</a>	Audio	<a href="http://www.ti.com/audio">www.ti.com/audio</a>
Data Converters	<a href="http://dataconverter.ti.com">dataconverter.ti.com</a>	Automotive	<a href="http://www.ti.com/automotive">www.ti.com/automotive</a>
DSP	<a href="http://dsp.ti.com">dsp.ti.com</a>	Broadband	<a href="http://www.ti.com/broadband">www.ti.com/broadband</a>
Interface	<a href="http://interface.ti.com">interface.ti.com</a>	Digital Control	<a href="http://www.ti.com/digitalcontrol">www.ti.com/digitalcontrol</a>
Logic	<a href="http://logic.ti.com">logic.ti.com</a>	Military	<a href="http://www.ti.com/military">www.ti.com/military</a>
Power Mgmt	<a href="http://power.ti.com">power.ti.com</a>	Optical Networking	<a href="http://www.ti.com/opticalnetwork">www.ti.com/opticalnetwork</a>
Microcontrollers	<a href="http://microcontroller.ti.com">microcontroller.ti.com</a>	Security	<a href="http://www.ti.com/security">www.ti.com/security</a>
		Telephony	<a href="http://www.ti.com/telephony">www.ti.com/telephony</a>
		Video & Imaging	<a href="http://www.ti.com/video">www.ti.com/video</a>
		Wireless	<a href="http://www.ti.com/wireless">www.ti.com/wireless</a>

Mailing Address: Texas Instruments  
Post Office Box 655303 Dallas, Texas 75265